

PRESSURE GAUGES - BOTTOM CONNECTION - DRY

APPLICATION : Measurement of the pressure of fluid liquids or gases upto 25 bar that are not highly viscous, subject to crystallisation or corrosive to copper or tin alloys.

SPECIFICATION : **Case :** impact resistant ABS. **Window :** shatter resistant acrylic. **Connection :** brass. **Sensitive element :** sealed copper alloy Bourdon tube. **Mechanism :** high precision watchmakers brass. **Joints :** soldered with tin alloy. **Indicator :** ABS. **Dial :** stoved enamel on aluminium. **Accuracy :** class 2.5. **Scale :** dual psi (outer) + bar (inner).

PRICES : Please note that prices shown are the current list price for each gauge or product. OEM and re-seller discounts are available together with progressive quantity discounts.

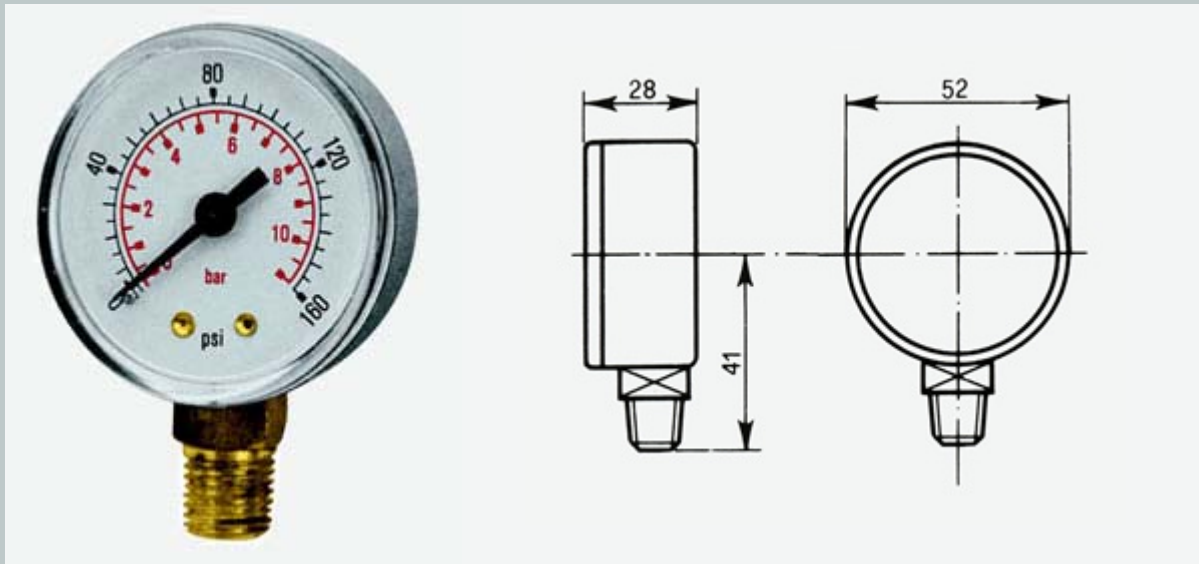

50mm (2") diameter, 1/4" BSP tapered thread, Dual Scale : psi+bar

Code 904 530 00	Vacuum -30"Hg	(-1 bar)	£ 6.95
Code 904 530 10	Range 15 psi	(1 bar)	£ 6.25
Code 904 531 11	Range 30 psi	(2 bar)	£ 5.25
Code 904 532 11	Range 60 psi	(4 bar)	£ 5.25
Code 904 533 11	Range 100 psi	(7 bar)	£ 5.25
Code 904 534 11	Range 160 psi	(11 bar)	£ 5.25
Code 904 534 21	Range 200 psi	(14 bar)	£ 5.25
Code 904 536 11	Range 300 psi	(21 bar)	£ 5.50
Code 904 536 12	Range 400 psi	(28 bar)	£ 5.50

cewal UK LTD

Unit 4C • Woodhall Business Park • Sudbury • Suffolk • CO10 1WH

Tel: +44 (0) 1787 882038 • Fax: +44 (0) 1787 882039

Email: info@cewal.co.uk • Website: www.cewal.co.uk