

## PRESSURE GAUGES - BACK CONNECTION - DRY

**APPLICATION :** Measurement of the pressure of fluid liquids or gases upto 25 bar that are not highly viscous, subject to crystallisation or corrosive to copper or tin alloys.

**SPECIFICATION :** **Case :** Impact resistant ABS. **Window :** shatter resistant acrylic. **Connection :** brass. **Sensitive element :** sealed copper alloy Bourdon tube. **Mechanism :** high precision watchmakers brass. **Joints :** soldered with tin alloy. **Indicator :** ABS. **Dial :** stoved enamel on aluminium. **Accuracy :** class 2.5. **Scale :** dual psi (outer) + bar (inner).

**PRICES :** Please note that prices shown are the current list price for each gauge or product. OEM and re-seller discounts are available together with progressive quantity discounts.

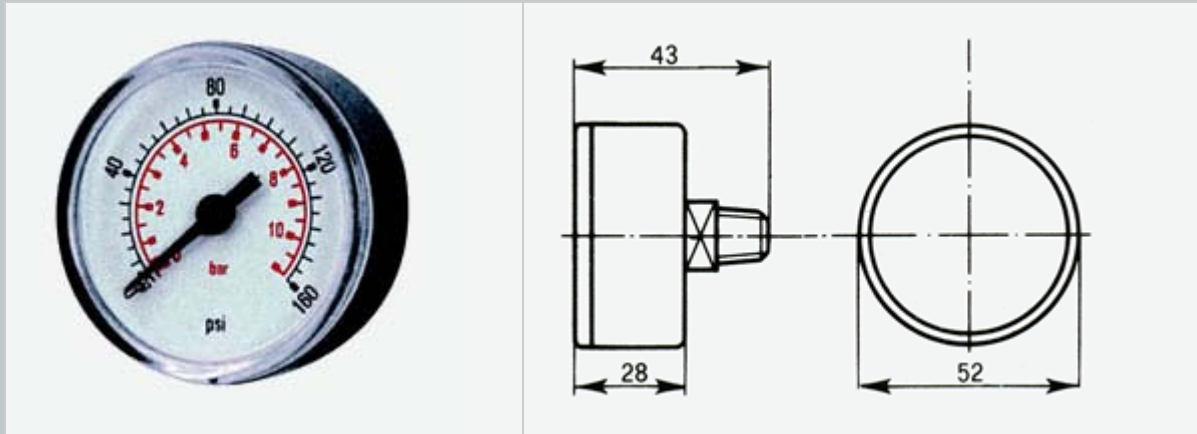

### 50mm (2") diameter, 1/4" BSP tapered thread, Dual Scale : psi+bar

Code 904 590 01	Vacuum -30"Hg	(-1 bar)	£ 6.95
Code 904 590 10	Range 15 psi	(1 bar)	£ 6.25
Code 904 591 11	Range 30 psi	(2 bar)	£ 5.25
Code 904 592 11	Range 60 psi	(4 bar)	£ 5.25
Code 904 593 11	Range 100 psi	(7 bar)	£ 5.25
Code 904 594 11	Range 160 psi	(11 bar)	£ 5.25
Code 904 594 21	Range 200 psi	(14 bar)	£ 5.25
Code 904 596 11	Range 300 psi	(21 bar)	£ 5.50
Code 904 596 12	Range 400 psi	(28 bar)	£ 5.50

### ABS 3 HOLE FRONT FLANGE

The Ø 50 gauges above can be supplied with a black ABS 3 hole front flange for panel mounting. Please add the letter "F" to order code

Addition price for front flange  
Ø 50 £1.50, Code 914 989 04

**cewal** UK LTD

Unit 4C • Woodhall Business Park • Sudbury • Suffolk • CO10 1WH

Tel: +44 (0) 1787 882038 • Fax: +44 (0) 1787 882039

Email: [info@cewal.co.uk](mailto:info@cewal.co.uk) • Website: [www.cewal.co.uk](http://www.cewal.co.uk)